



## Key Features

iArte model decorative wall luminaire range with timeless design and energy efficient LED lighting. Ideal for illuminating the stylish buildings as well as historical architecture with superior flexibility and high performance. Designed to last in extremely harsh environments.



## Key Data

<b>LED Type</b>	High efficiency LEDs, available in 2700K, 3000K, 4000K, 5000K, 6500K CCT tolerance within a 3-step MacAdams ellipse and LM80 compliant. Custom LED color combinations available.
<b>Nominal Voltage</b>	220V-240V AC, 50/60Hz
<b>Color Rendering Index</b>	CRI ≥ 80 standard and CRI ≥ 90 on request.
<b>Optics</b>	40° / 60° / 90° / M3
<b>Materials</b>	Corrosion resistant double layer polyester powder coated paint finish die cast aluminium housing with stainless steel screws (A4 grade) and silicone gaskets. Power unit is built in. Available in anthracite gray as a standard finish or any desired RAL colour.
<b>Optional Coating</b>	Marine grade.
<b>Diffuser</b>	Thermal-shock resistant tempered glass.
<b>LED Life Time</b>	L90 - B10 > 100,000h
<b>Operating Temperature</b>	-40°C / +55°C
<b>Power Factor</b>	>0.95
<b>Control Systems</b>	On-Off, 1-10V DIM, DALI Interface.
<b>Protection Class</b>	IP65
<b>Impact Resistance</b>	IK08
<b>Insulation Class</b>	Class I
<b>Conformity</b>	Complies with European Standards EN 60598 and CE certified.

Technical Drawing

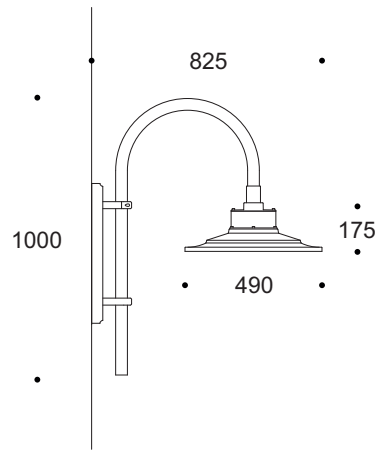

Information

CODE	POWER CONSUMPTION	LUMEN OUTPUT (lm) 3000K / 4000K	COLOUR TEMPERATURE
WA7744	54W	5940 / 6480	3000K / 4000K

Light Distribution Curve

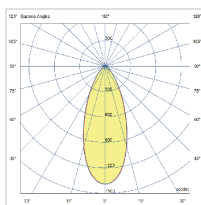

40°

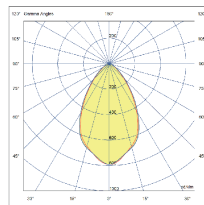

60°

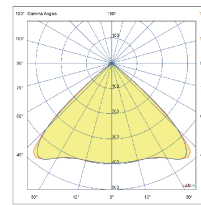

90°

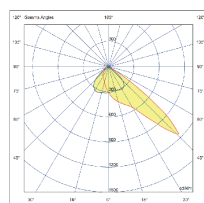

Asymmetric 90°

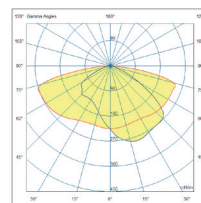

M3