

Technical Drawing

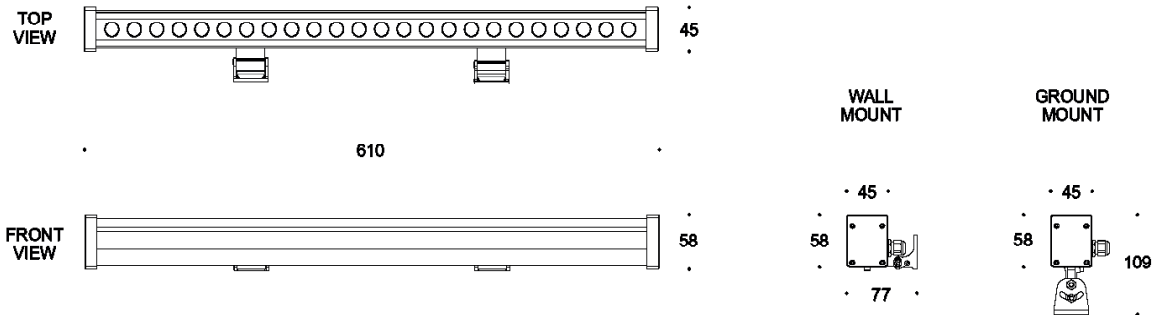

Information

CODE	LENGTH (mm)	LED QTY	POWER CONSUMPTION	LUMEN OUTPUT (lm) RGB
AR9466301 RGB	610	24	28W	1506

Light Distribution Curve

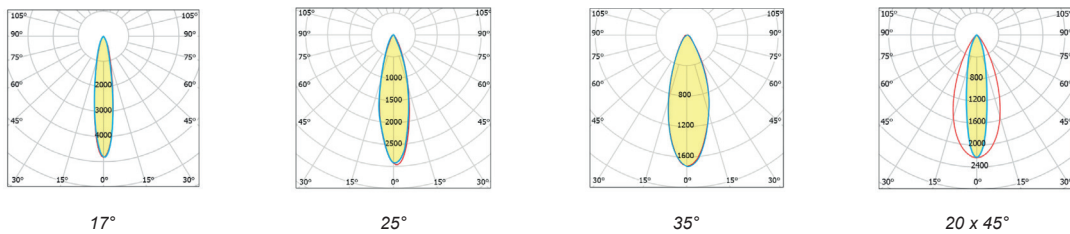

Accessories



Wall Mounting Bracket
Code: WB1001



Ground Mounting Bracket
Code: GB1001



IP68 Plug Power Connector Set (Two pieces)
Code: CON1202



T-Connector
Code: TC4001