



## Key Features

iLinus is a high-performance linear luminaire suitable for a wide range of wall washing, accent, surface grazing, and indirect lighting applications in architectural, hospitality, and retail environments. It has multiple customization options to illuminate interior walls, exterior facades, and unique architectural details.

Designed to last in extremely harsh environments.

Monochrome or DALI controllable, easy to install with the remote universal power supply and connect via combined power and data connectors.



## Key Data

<b>LED Type</b>	High efficiency LEDs, Monochrome available in 2700K, 3000K, 4000K, 5000K, 6500K CCT tolerance within a 3-step MacAdams ellipse and LM80 compliant.
<b>Nominal Voltage</b>	198-264 V AC, 50/60Hz
<b>Optional Voltage</b>	24V DC / PS (Constant Voltage)
<b>Color Rendering Index</b>	CRI ≥ 80 standard and CRI ≥ 90 on request.
<b>Optics</b>	Standard: 18° / 25° / 30°x90° / 60°x110° / 90°x110°. Custom optics upon request.
<b>Materials</b>	Corrosion resistant extruded anodized aluminium housing (EN AW-6060) with stainless steel screws (A4 grade) and silicone rubber gaskets. End to end connection via power connectors. Includes wall or ground mounting brackets. Power unit is built in.
<b>Diffuser</b>	Thermal-shock resistant 5mm tempered glass.
<b>LED Life Time</b>	L80 B10 70.000h Ta 25°C L80 B10 50.000h Ta 40°C
<b>Operating Temperature</b>	-40°C / +55°C
<b>Power Factor</b>	>0.95
<b>Control Systems</b>	1-10V DIM, DALI Interface.
<b>Protection Class</b>	IP66
<b>Impact Resistance</b>	IK09
<b>Insulation Class</b>	Class I
<b>Conformity</b>	Complies with European Standards EN 60598 and CE certified.

Technical Drawing

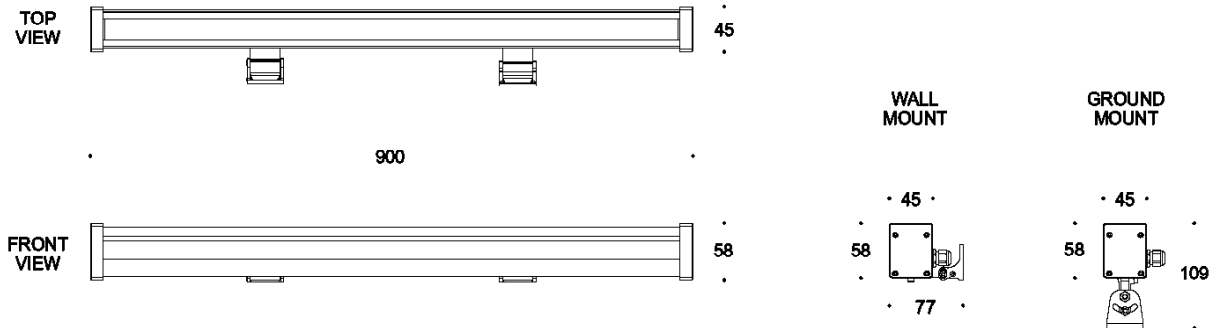

Information

CODE	LENGTH (mm)	LED QTY	POWER CONSUMPTION	LUMEN OUTPUT (lm) 3000K / 4000K
AR9344502 MONO	900	96	31W	4670 / 4957

Light Distribution Curve

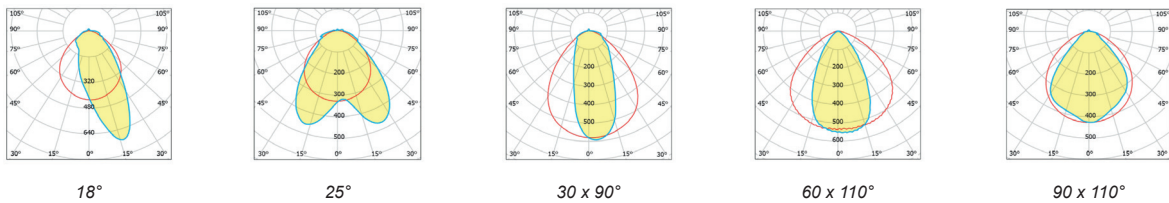

Accessories



**Wall Mounting Bracket**  
Code: WB1001



**Ground Mounting Bracket**  
Code: GB1001



**IP68 Plug Power Connector Set**  
Code: CON1201



**T-Connector**  
Code: TC4001