



Key Features

Transform your outdoor spaces into inviting, comfortable environments with the iTubo bollard.

Featuring a compact LED floodlight range, it beautifully accentuates architecture, greenery, and monumental forms while bringing light and warmth to walls and facades.

With its minimalist, modern design, iTubo blends naturally into any setting — elegant, discrete, and timeless.

Built to perform flawlessly in the harshest environments, iTubo stands for durability and design excellence.



Key Data

LED Type	High efficiency LEDs, available in 2700K, 3000K, 4000K, 5000K, 6500K CCT tolerance within a 3-step MacAdams ellipse and LM80 compliant.
Nominal Voltage	220V-240V AC, 50/60Hz
Color Rendering Index	CRI ≥ 80 standard and CRI ≥ 90 on request.
Light Distribution	Standard: 12° / 25° / 30° / 45° / 60°
Materials	Corrosion resistant double layer polyester powder coated paint finish aluminium housing (EN AW-6060) with stainless steel screws (A4 grade) and silicone gaskets. Power unit is built in. Available in anthracite gray as a standard finish or any desired RAL colour.
Optional Coating	Marine grade.
Mounting	Adjustable bracket.
Diffuser	Thermal-shock resistant tempered glass.
LED Life Time	L90 - B10 > 100,000h
Operating Temperature	-40°C / +55°C
Power Factor	>0.95
Control Systems	On/Off, DALI Interface. (EXTERNAL)
Protection Class	IP67
Impact Resistance	IK08
Insulation Class	Class I
Conformity	Complies with European Standards EN 60598 and CE certified.

Technical Drawing

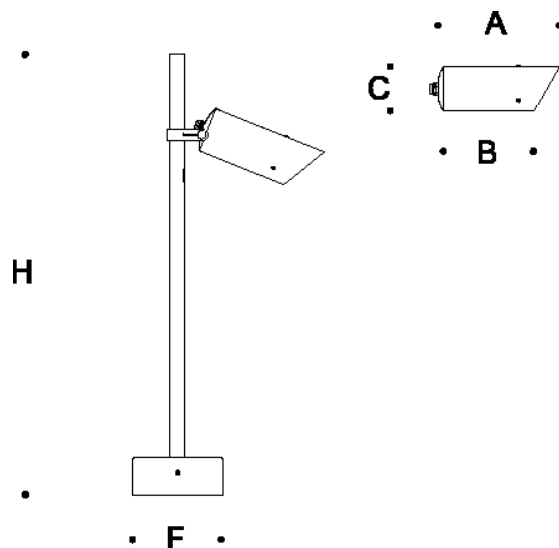

Information

CODE	POWER CONSUMPTION	LUMEN OUTPUT (lm)	COLOUR TEMPERATURE	A (mm)	B (mm)	C (mm)	H (mm)	F (mm)
LB2793	6W	810 / 852	3000K / 4000K	162	120	60	600	120

Light Distribution Curve

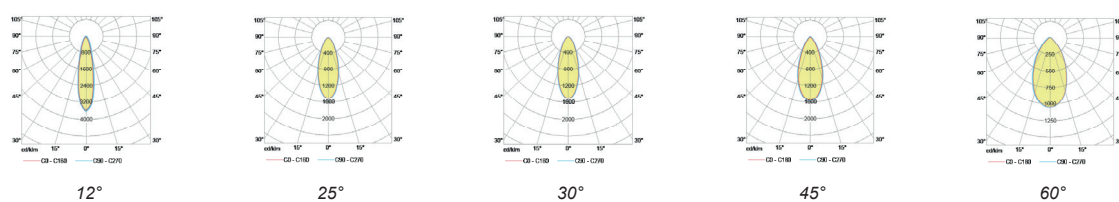

Accessories



Glare Shield
Code: GS9001