

Key Features

iErgo Flow is a multi purpose urban lighting column suitable for squares, roads, pedestrian precincts, car parks and sports grounds.

Advanced thermal design with cutting-edge manufacturing process and materials. The system offers rotationally symmetrical light distribution narrow to wide beam.

iErgo Series provide an elegant solution for lighting various environments in towns and cities such as urban and residential streets, squares, parks, pedestrian areas and car parks.

Designed to last in extremely harsh environments.



Key Data

LED Type	High efficiency LEDs, available in 2700K, 3000K, 4000K, 5000K, 6500K CCT tolerance within a 3-step MacAdams ellipse and LM80 compliant.
Nominal Voltage	220V-240V AC, 50/60Hz
Color Rendering Index	CRI ≥ 80 standard and CRI ≥ 90 on request.
Optics	30° / 45° / 60° / 90°
Materials	Corrosion resistant double layer polyester powder coated paint finish die cast aluminium housing with stainless steel screws (A4 grade) and silicone gaskets. Power unit is built in. Available in anthracite gray as a standard finish or any desired RAL colour. Mounting bracket made of aluminium with polyester powder coating.
Optional Coating	Marine grade.
Mounting	Adjustable bracket.
Diffuser	Thermal-shock resistant tempered glass with no visible screws.
LED Life Time	L90 - B10 > 100,000h
Operating Temperature	-40°C / +55°C
Power Factor	>0.95
Control Systems	On - Off, 1-10V DIM, DMX / RDM, DALI Interface.
Protection Class	IP66
Impact Resistance	IK09
Insulation Class	Class I
Conformity	Complies with European Standards EN 60598 and CE certified.

Technical Drawing

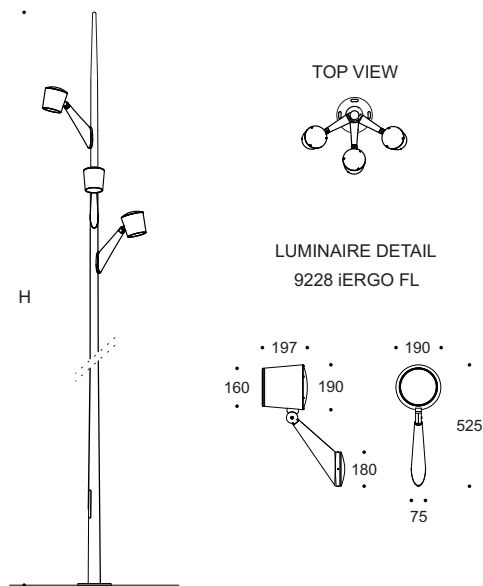

Information

CODE	POWER CONSUMPTION	LUMEN OUTPUT (lm) 3000K / 4000K	COLOUR TEMPERATURE	H (mm)
UA18711	48W	6480 / 6816	3000K / 4000K	4000 - 6000

*Anchorage set included.

*Flange cover to be ordered separately.

Light Distribution Curve

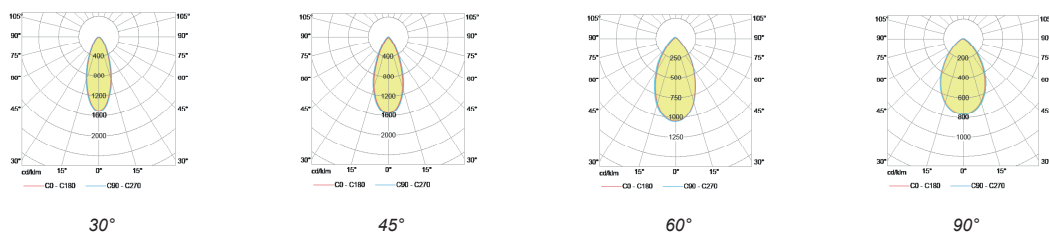

Accessories



Glare Shield
Code: GS9001



Honeycomb Louvre
Code: HC3002