



## Key Features

iErgo Platz is a multi purpose urban lighting column suitable for squares, roads, pedestrian precincts, car parks and sports grounds.

Advanced thermal design with cutting-edge manufacturing process and materials.

The system offers rotationally symmetrical light distribution narrow to wide beam.

Designed to last in extremely harsh environments.



## Key Data

<b>LED Type</b>	High efficiency LEDs, available in 2700K, 3000K, 4000K, 5000K, 6500K CCT tolerance within a 3-step MacAdams ellipse and LM80 compliant.
<b>Nominal Voltage</b>	220V-240V AC, 50/60Hz
<b>Color Rendering Index</b>	CRI ≥ 80 standard and CRI ≥ 90 on request.
<b>Optics</b>	30° / 45° / 60° / 90°
<b>Materials</b>	Corrosion resistant double layer polyester powder coated paint finish die cast aluminium housing with stainless steel screws (A4 grade) and silicone gaskets. Power unit is built in. Available in anthracite gray as a standard finish or any desired RAL colour. Mounting bracket made of aluminium with polyester powder coating.
<b>Optional Coating</b>	Marine grade.
<b>Mounting</b>	Adjustable bracket.
<b>Diffuser</b>	Thermal-shock resistant tempered glass with no visible screws.
<b>LED Life Time</b>	L90 - B10 > 100,000h
<b>Operating Temperature</b>	-40°C / +55°C
<b>Power Factor</b>	>0.95
<b>Control Systems</b>	On - Off, 1-10V DIM, DMX / RDM, DALI Interface.
<b>Protection Class</b>	IP66
<b>Impact Resistance</b>	IK09
<b>Insulation Class</b>	Class I
<b>Conformity</b>	Complies with European Standards EN 60598 and CE certified.

Technical Drawing

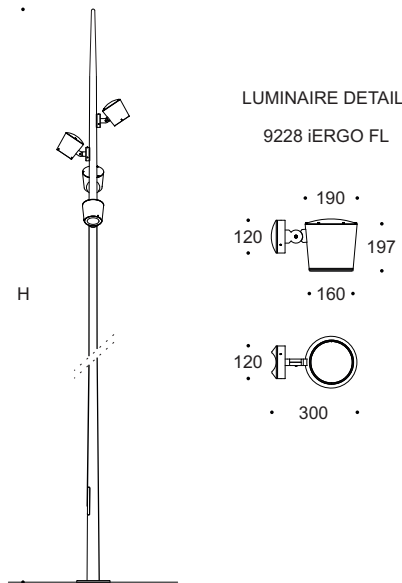

Information

CODE	POWER CONSUMPTION	LUMEN OUTPUT (lm) 3000K / 4000K	COLOUR TEMPERATURE	H (mm)
UA18111	48W	6480 / 6816	3000K / 4000K	4000 - 6000

\*Anchorage set included.

\*Flange cover to be ordered separately.

Light Distribution Curve

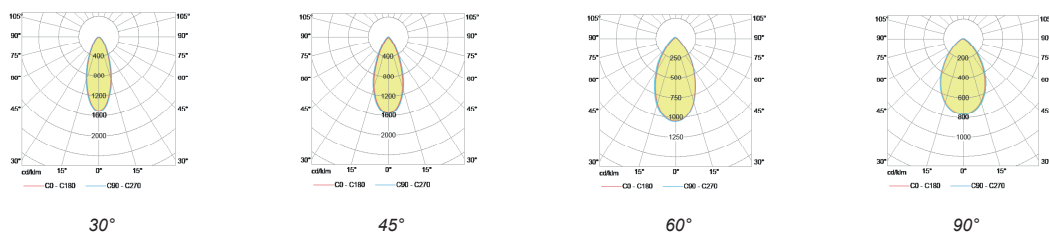

Accessories



**Glare Shield**  
Code: GS9001



**Honeycomb Louvre**  
Code: HC3002