

Key Features

iCubus offers a wide range of options for realizing impressive and efficient lighting concepts and individual design solutions within urban spaces.

Functional LED outdoor pole mounted luminaire, with wide range of beams, sizes and powers, ideal for residential, urban and landscape lighting.

Architectural floodlight range inspires architects, designers and system integrators with its exceptional quality, a variety of beam angles and remarkable creativity.

Designed to last in extremely harsh environments.



Key Data

LED Type	High efficiency LEDs, available in 2700K, 3000K, 4000K, 5000K, 6500K CCT tolerance within a 3-step MacAdams ellipse and LM80 compliant.
Nominal Voltage	220V-240V AC, 50/60Hz
Color Rendering Index	CRI ≥ 80 standard and CRI ≥ 90 on request.
Optics	40° / 60° / 90° / M3
Materials	Corrosion resistant double layer polyester powder coated paint finish die cast aluminium housing with stainless steel screws (A4 grade) and silicone gaskets. Power unit is built in. Available in anthracite gray as a standard finish or any desired RAL colour. Mounting bracket made of aluminium with polyester powder coating.
Optional Coating	Marine grade.
Mounting	Adjustable bracket.
Diffuser	Thermal-shock resistant tempered glass with no visible screws.
LED Life Time	L90 - B10 > 100,000h
Operating Temperature	-40°C / +55°C
Power Factor	>0.95
Control Systems	On - Off, 1-10V DIM, DMX / RDM, DALI Interface.
Protection Class	IP66
Impact Resistance	IK09
Insulation Class	Class I
Conformity	Complies with European Standards EN 60598 and CE certified.

Technical Drawing

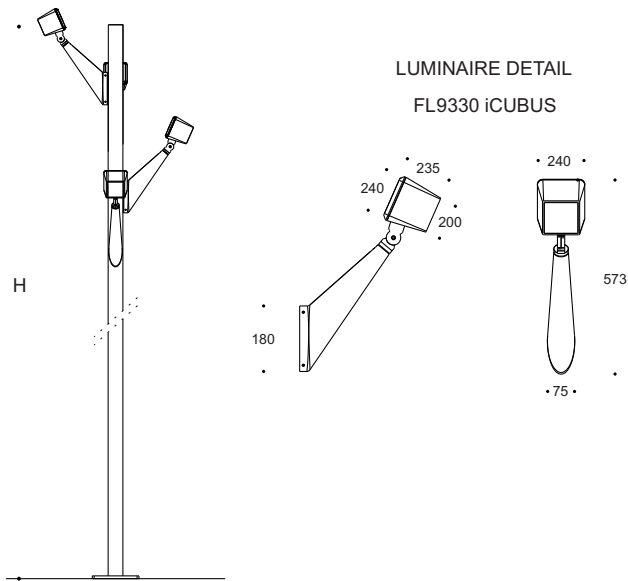

Information

CODE	POWER CONSUMPTION	LUMEN OUTPUT (lm) 3000K / 4000K	COLOUR TEMPERATURE	H (mm)
UA17112	72W	9720 / 10224	3000K / 4000K	6000 - 8000

*Anchorage set included.

*Flange cover to be ordered separately.

Light Distribution Curve

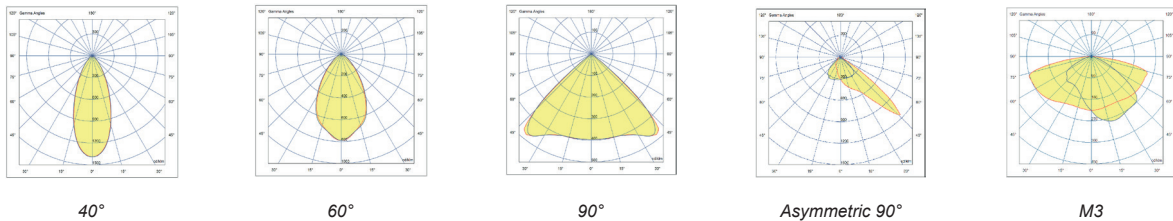

Accessories



Glare Shield
Code: GS9001

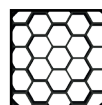

Honeycomb Louvre
Code: HC3002