



## Key Features

iRackett is a modern shaped lighting luminaire with elegant minimal design blends in modern architectural environments. The range of luminaires is ideal for the attractive and efficient lighting of roads, paths and plazas.

The compact design and reduced size of the luminaire allow its addition with balance and discretion to any urban context, from big cities to small district towns.

Designed to last in extremely harsh environments.



## Key Data

<b>LED Type</b>	High efficiency LEDs, available in 2700K, 3000K, 4000K, 5000K, 6500K CCT tolerance within a 3-step MacAdams ellipse and LM80 compliant.
<b>Nominal Voltage</b>	220V-240V AC, 50/60Hz
<b>Color Rendering Index</b>	CRI ≥ 80 standard and CRI ≥ 90 on request.
<b>Optics</b>	40° / 60° / 90° / M3
<b>Materials</b>	Corrosion resistant double layer polyester powder coated paint finish die cast aluminium housing with stainless steel screws (A4 grade) and silicone gaskets. Power unit is built in. Available in anthracite gray as a standard finish or any desired RAL colour. BSISQ® LED Module.
<b>Optional Coating</b>	Marine grade.
<b>Diffuser</b>	Thermal-shock resistant tempered glass.
<b>LED Life Time</b>	L90 - B10 > 100,000h
<b>Operating Temperature</b>	-40°C / +55°C
<b>Power Factor</b>	>0.95
<b>Control Systems</b>	On - Off, 1-10V DIM, DALI Interface.
<b>Protection Class</b>	IP66
<b>Impact Resistance</b>	IK08
<b>Insulation Class</b>	Class I
<b>Conformity</b>	Complies with European Standards EN 60598 and CE certified.

Technical Drawing

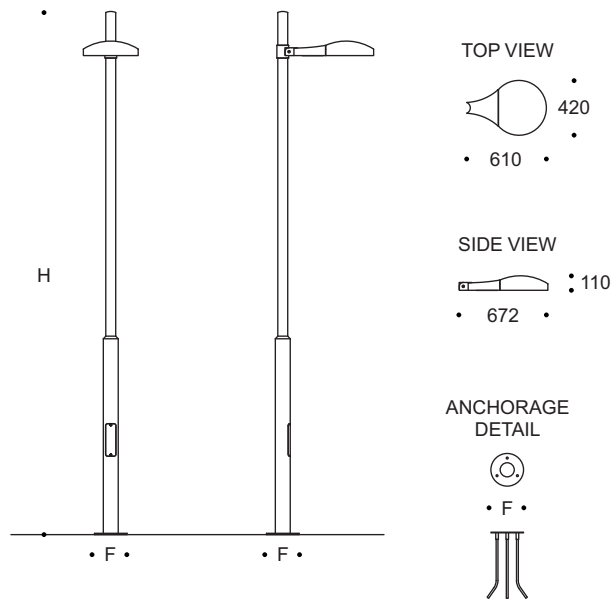

Information

CODE	POWER CONSUMPTION	LUMEN OUTPUT (lm) 3000K / 4000K	COLOUR TEMPERATURE	H (mm)	F (mm)
UA1682	144W	19440 / 20448	3000K / 4000K	6000 - 10000	250 - 350

\*Anchorage set included.

\*Poles and flange cover to be ordered separately.

Light Distribution Curve

