

Key Features

iFly offers outstanding light efficiency with wide beam asymmetrical optics. The LED system offers durability and optimal light output.

The light emission is directed completely downwards to ensure powerful light distribution and the compact design and reduced size of the luminaire allow its addition with balance and discretion to any urban context, from big cities to small district towns.

BSISQ® LED Module integrated.

Designed to last in extremely harsh environments.



Key Data

LED Type	High efficiency LEDs, available in 2700K, 3000K, 4000K, 5000K, 6500K CCT tolerance within a 3-step MacAdams ellipse and LM80 compliant.
Nominal Voltage	220V-240V AC, 50/60Hz
Color Rendering Index	CRI ≥ 80 standard and CRI ≥ 90 on request.
Light Distribution	60° / 90° / M3
Materials	Corrosion resistant double layer polyester powder coated paint finish die cast aluminium housing with stainless steel screws (A4 grade) and silicone gaskets. Power unit is built in. Available in anthracite gray as a standard finish or any desired RAL colour. BSISQ® LED Module.
Optional Coating	Marine grade.
Diffuser	Thermal-shock resistant tempered glass.
LED Life Time	L90 - B10 > 100,000h
Operating Temperature	-40°C / +55°C
Power Factor	>0.95
Control Systems	On-Off, 1-10V DIM, DALI Interface.
Protection Class	IP66
Impact Resistance	IK08
Insulation Class	Class I
Conformity	Complies with European Standards EN 60598 and CE certified.

Technical Drawing

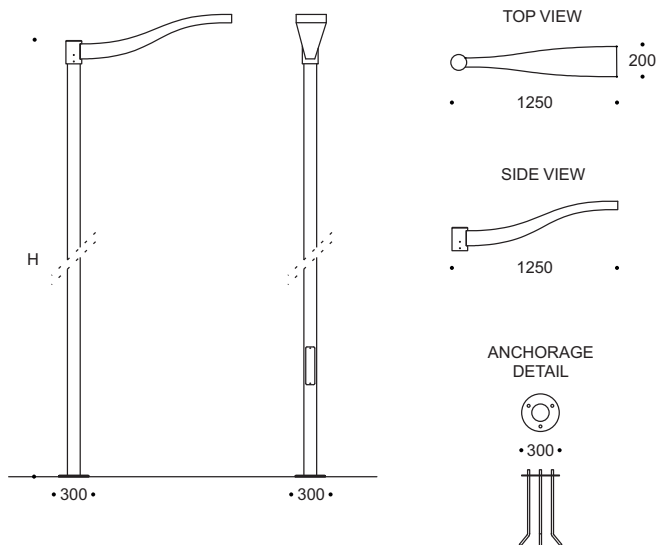

Information

Code	POWER CONSUMPTION	LUMEN OUTPUT (lm) 3000K / 4000K	COLOUR TEMPERATURE	H (mm)
UA1514	82W	11070 / 11644	3000K / 4000K	6000 - 8000

*Anchorage set included.

*Poles and flange cover to be ordered separately.

Light Distribution Curve

