



Key Features

iBrezel is a range of urban lighting luminaires designed to provide excellent, environmentally friendly lighting without compromising on architectural appearance.

Lighting system for urban areas with asymmetrical and symmetrical optics with independent modules for excellent illuminance uniformity and optimum visual comfort.

The distinctive designs are clearly linked yet allow modularity.

BSIFIX® Modules integrated.

Designed to last in extremely harsh environments.



Key Data

LED Type	High efficiency LEDs, available in 2700K, 3000K, 4000K, 5000K, 6500K CCT tolerance within a 3-step MacAdams ellipse and LM80 compliant.
Nominal Voltage	220V-240V AC, 50/60Hz
Color Rendering Index	CRI ≥ 80 standard and CRI ≥ 90 on request.
Optics	18° x 38°
Materials	Corrosion resistant double layer polyester powder coated paint finish die cast aluminium housing with stainless steel screws (A4 grade) and silicone gaskets. Power unit is built in. Available in anthracite gray as a standard finish or any desired RAL colour. BSIFIX® LED Module.
Optional Coating	Marine grade.
Diffuser	High impact and heat resistant polycarbonate with UV protection.
LED Life Time	L90 - B10 > 100,000h
Operating Temperature	-40°C / +55°C
Power Factor	>0.95
Control Systems	On - Off, 1-10V DIM, DALI Interface.
Protection Class	IP65
Impact Resistance	IK08
Insulation Class	Class I
Conformity	Complies with European Standards EN 60598 and CE certified.

Technical Drawing

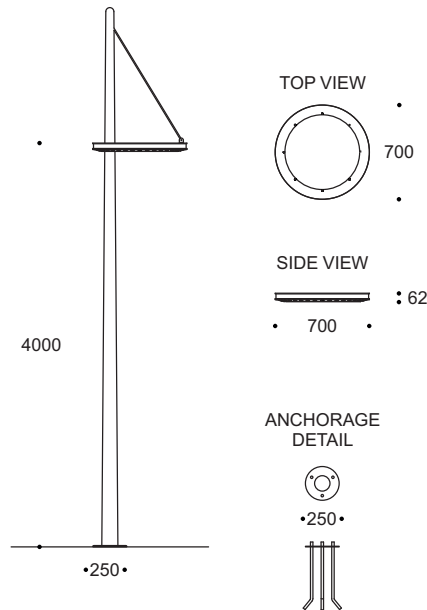

Information

CODE	POWER CONSUMPTION	LUMEN OUTPUT (lm) 3000K / 4000K	COLOUR TEMPERATURE
UA1406	54W	5940 / 6480	3000K / 4000K

*Anchorage set included.

*Poles and flange cover to be ordered separately.

Light Distribution Curve

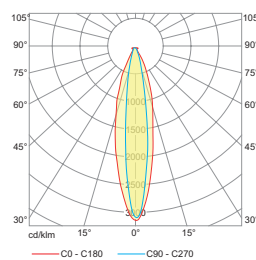

18° x 38°