



Key Features

Attractive and modern design; the iUntel bollard provides functional and aesthetic lighting for any external, residential or commercial space.

The product provides optimum visual comfort through the smooth reflective surface.

Outdoor bollard series with minimal and robust design in different heights, ideal for ambient illumination of outdoor areas, paths, parks, walkways and gardens.

Designed to last in extremely harsh environments.



Key Data

LED Type	High efficiency LEDs, available in 2700K, 3000K, 4000K, 5000K, 6500K CCT tolerance within a 3-step MacAdams ellipse and LM80 compliant.
Nominal Voltage	220V-240V AC, 50/60Hz
Color Rendering Index	CRI ≥ 80 standard and CRI ≥ 90 on request.
Light Distribution	M3
Materials	Corrosion resistant double layer polyester powder coated paint finish die cast aluminium housing, aluminium extruded column (EN AW-6060) with stainless steel screws (A4 grade) and silicone gaskets. Power unit is built in. Available in anthracite gray as a standard finish or any desired RAL colour.
Optional Coating	Marine grade.
Diffuser	Thermal-shock resistant tempered glass.
LED Life Time	L90 - B10 > 100,000h
Operating Temperature	-40°C / +55°C
Power Factor	>0.95
Control Systems	On-Off, 1-10V DIM, DALI Interface.
Protection Class	IP66
Impact Resistance	IK08
Insulation Class	Class I
Conformity	Complies with European Standards EN 60598 and CE certified.

Technical Drawing

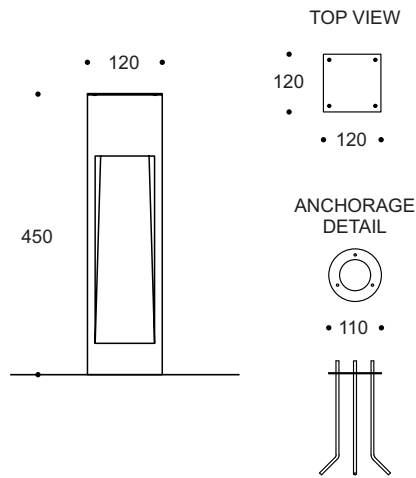

Information

CODE	POWER CONSUMPTION	LUMEN OUTPUT (lm) 3000K / 4000K	COLOUR TEMPERATURE
LB742511	12W	900 / 1020	3000K / 4000K

*Anchorage set included.

*Flange cover to be ordered separately.

Light Distribution Curve

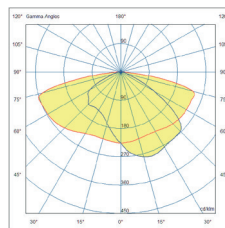

M3

Accessories



Fuse Box Thin
Code: FB1001



Fuse Box Large
Code: FB1002