



Key Features

iCupio is a perfect synergy of sophisticated design and practical functionality.

Constructed from high quality marine grade stainless steel iCupio bollard is extremely durable. Innovative design to highlight urban areas, bound pedestrian zones, enhances the building architecture.

Ideal for creating visual guidance with exceptional visual comfort using LED technology. Made of stainless steel 304L/316L for high stability.

Designed to last in extremely harsh environments.



Key Data

LED Type	High efficiency LEDs, available in 2700K, 3000K, 4000K, 5000K, 6500K CCT tolerance within a 3-step MacAdams ellipse and LM80 compliant.
Nominal Voltage	220V-240V AC, 50/60Hz
Color Rendering Index	CRI ≥ 80 standard and CRI ≥ 90 on request.
Light Distribution	120°
Materials	Corrosion resistant marine grade stainless steel AISI 304L / 316L housing with stainless steel screws (A4 grade) and silicone gaskets. Power unit is built in.
Optional Coating	Marine grade.
Diffuser	Shockproof PMMA UV Stabilised Diffuser.
LED Life Time	L90 - B10 > 100,000h
Operating Temperature	-40°C / +55°C
Power Factor	>0.95
Control Systems	On-Off, 1-10V DIM, DALI Interface.
Protection Class	IP66
Impact Resistance	IK08
Insulation Class	Class I
Conformity	Complies with European Standards EN 60598 and CE certified.

Technical Drawing

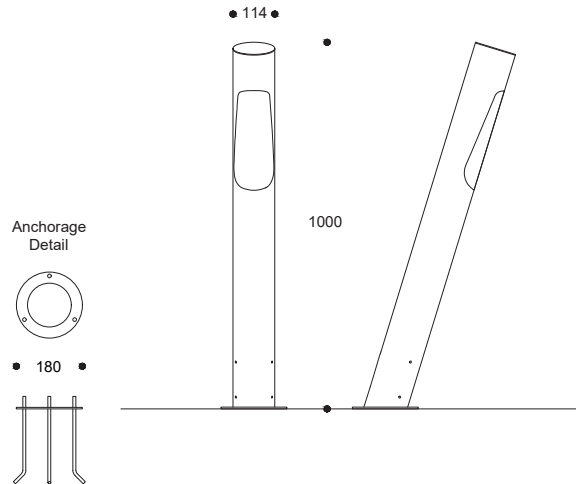

Information

CODE	POWER CONSUMPTION	LUMEN OUTPUT (lm) 3000K / 4000K	COLOUR TEMPERATURE
LB67521	12W	900 / 960	3000K / 4000K

*Anchorage set included.

*Flange cover to be ordered separately.

Light Distribution Curve

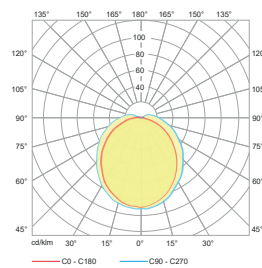

Diffused Beam

Accessories



Fuse Box Thin
Code: FB1001



Fuse Box Large
Code: FB1002