



## Key Features

Minimal design bollard, iRuta R is ideal for discrete illumination of walkways and residential areas.

Offers glare-free illumination and visual comfort, creating a welcoming atmosphere.

Bollard and light column series with minimal and robust design in different heights, ideal for glare-free lighting of squares, avenues, paths, parks, walkways and gardens.

Designed to last in extremely harsh environments.



## Key Data

<b>LED Type</b>	High efficiency LEDs, available in 2700K, 3000K, 4000K, 5000K, 6500K CCT tolerance within a 3-step MacAdams ellipse and LM80 compliant.
<b>Nominal Voltage</b>	220V-240V AC, 50/60Hz
<b>Color Rendering Index</b>	CRI ≥ 80 standard and CRI ≥ 90 on request.
<b>Light Distribution</b>	Rotational light distribution.
<b>Materials</b>	Corrosion resistant double layer polyester powder coated paint finish die cast aluminium housing, aluminium extruded column (EN AW-6060) with stainless steel screws (A4 grade) and silicone gaskets. Power unit is built in. Available in anthracite gray as a standard finish or any desired RAL colour.
<b>Optional Coating</b>	Marine grade.
<b>Diffuser</b>	Shockproof PMMA UV Stabilised Diffuser.
<b>LED Life Time</b>	L90 - B10 > 100,000h
<b>Operating Temperature</b>	-40°C / +55°C
<b>Power Factor</b>	>0.95
<b>Control Systems</b>	On-Off, 1-10V DIM, DALI Interface.
<b>Protection Class</b>	IP65
<b>Impact Resistance</b>	IK09
<b>Insulation Class</b>	Class I
<b>Conformity</b>	Complies with European Standards EN 60598 and CE certified.

## Technical Drawing

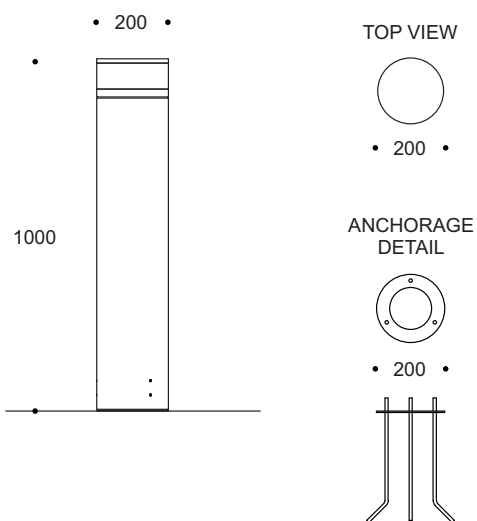

## Information

CODE	POWER CONSUMPTION	LUMEN OUTPUT (lm) 3000K / 4000K	COLOUR TEMPERATURE
LB2766	36W	2700 / 3060	3000K / 4000K

\*Anchorage set included.

\*Flange cover to be ordered separately.

## Accessories



*Fuse Box Thin*  
Code: FB1001



*Fuse Box Large*  
Code: FB1002