



## Key Features

The iLotus bollard luminaire in 316 stainless steel is stylish, modern and durable and is ideal for lighting parking lots, paths or golf courses where a high level of light is required.

Marine Grade bollard is designed to withstand the most challenging of conditions making it perfect for coastal areas.

Designed to last in extremely harsh environments.



## Key Data

<b>LED Type</b>	High efficiency LEDs, available in 2700K, 3000K, 4000K, 5000K, 6500K CCT tolerance within a 3-step MacAdams ellipse and LM80 compliant.
<b>Nominal Voltage</b>	220V-240V AC, 50/60Hz
<b>Color Rendering Index</b>	CRI ≥ 80 standard and CRI ≥ 90 on request.
<b>Light Distribution</b>	Rotational light distribution.
<b>Materials</b>	Corrosion resistant stainless steel housing (LB2062) with stainless steel screws (A4 grade) and silicone gaskets. Power unit is built in. Available in anthracite gray as a standard finish or any desired RAL colour.
<b>Optional Coating</b>	Marine grade.
<b>Diffuser</b>	Shockproof PMMA UV Stabilised Diffuser.
<b>LED Life Time</b>	L90 - B10 > 100,000h
<b>Operating Temperature</b>	-40°C / +55°C
<b>Power Factor</b>	>0.95
<b>Control Systems</b>	On-Off, 1-10V DIM, DALI Interface.
<b>Protection Class</b>	IP65
<b>Impact Resistance</b>	IK08
<b>Insulation Class</b>	Class I
<b>Conformity</b>	Complies with European Standards EN 60598 and CE certified.

Technical Drawing

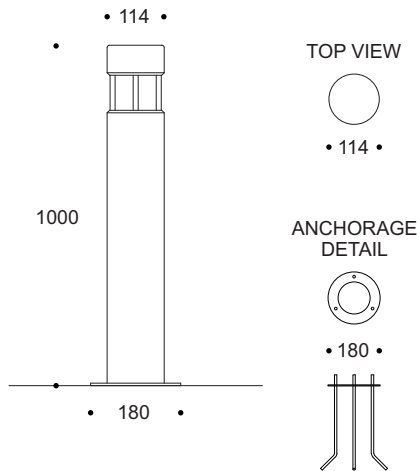

Information

CODE	POWER CONSUMPTION	LUMEN OUTPUT (lm) 3000K / 4000K	COLOUR TEMPERATURE
LB2066 SS	12W	900 / 1020	3000K / 4000K

\*Anchorage set included.

\*Flange cover to be ordered separately.

Light Distribution Curve

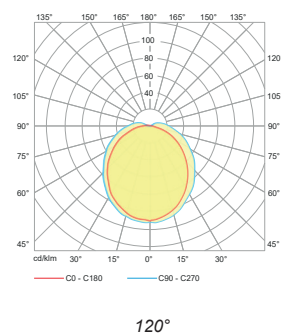

Accessories



Fuse Box Thin  
Code: FB1001



Fuse Box Large  
Code: FB1002