

Key Features

LED lighting with innovative technology and modern design.

iMistral Plus offers outstanding light efficiency and integrates itself through the design into historic and modern surroundings with wide beam asymmetrical optics.

The LED system offers durability and optimal lumen output.

BSISQ® LED Module integrated.

Designed to last in extremely harsh environments.



Key Data

LED Type	High efficiency LEDs, available in 2700K, 3000K, 4000K, 5000K, 6500K CCT tolerance within a 3-step MacAdams ellipse and LM80 compliant.
Nominal Voltage	220V-240V AC, 50/60Hz
Color Rendering Index	CRI ≥ 80 standard and CRI ≥ 90 on request.
Light Distribution	40° / 60° / 90° / M3
Materials	Corrosion resistant double layer polyester powder coated paint finish die cast aluminium housing, aluminium extruded column (EN AW-6060) with stainless steel screws (A4 grade) and silicone gaskets. Power unit is built in. Available in anthracite gray as a standard finish or any desired RAL colour. BSISQ® LED Module.
Optional Coating	Marine grade.
Diffuser	Thermal-shock resistant tempered glass.
LED Life Time	L80 B10 70.000h Ta 25°C L80 B10 50.000h Ta 40°C
Operating Temperature	-40°C / +55°C
Power Factor	>0.95
Control Systems	On - Off, DALI Interface.
Protection Class	IP66
Impact Resistance	IK08
Insulation Class	Class I
Conformity	Complies with European Standards EN 60598 and CE certified.

Technical Drawing

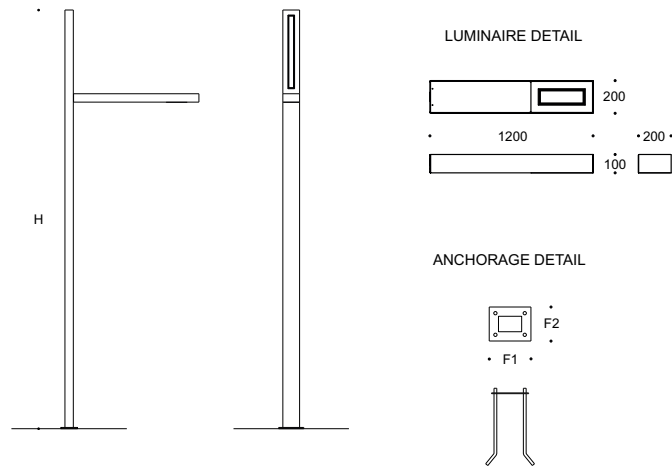

Information

CODE	POWER CONSUMPTION	LUMEN OUTPUT (lm) 3000K / 4000K	COLOUR TEMPERATURE
LB1387	96W	12960 / 13632	3000K / 4000K

*Integrated Pole LED Module Power: 18W Standard

*Anchorage set included.

*Flange cover to be ordered separately.

Poles



ALUMINIUM POLE	HEIGHT (mm)	DIMENSIONS (mm)	F1 x F2 (mm)
RCP514-AL	6000	200 x 100	300 x 220
RCP515-AL	7000	200 x 100	400 x 300

Light Distribution Curve

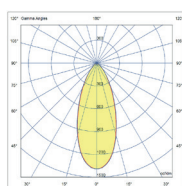

40°

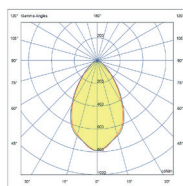

60°

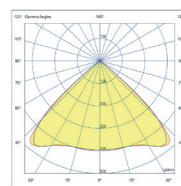

90°

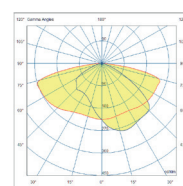

M3