



Key Features

iRuta Decor with a range of customised shapes, ideal for lighting modern and architectural streets, squares, parks, public areas and entryways.

Decorative patterns highlighted with LEDs offers joy of decor and lighting creativity.

Designed to last in extremely harsh environments.



Key Data

LED Type	High efficiency LEDs, available in 2700K, 3000K, 4000K, 5000K, 6500K CCT tolerance within a 3-step MacAdams ellipse and LM80 compliant.
Nominal Voltage	220V-240V AC, 50/60Hz
Color Rendering Index	CRI ≥ 80 standard and CRI ≥ 90 on request.
Light Distribution	Asymmetrical or rotationally symmetrical distribution . 40°/ 60° / 90° / M3
Materials	Corrosion resistant double layer polyester powder coated paint finish die cast aluminium housing, aluminium extruded column (EN AW-6060) with stainless steel screws (A4 grade) and silicone gaskets. Power unit is built in. Available in anthracite gray as a standard finish or any desired RAL colour.
Optional Coating	Marine grade.
Diffuser	Thermal-shock resistant tempered glass.
LED Life Time	L90 - B10 > 100,000h
Operating Temperature	-40°C / +55°C
Power Factor	>0.95
Control Systems	DALI Interface.
Protection Class	IP65
Impact Resistance	IK08
Insulation Class	Class I
Conformity	Complies with European Standards EN 60598 and CE certified.

Technical Drawing

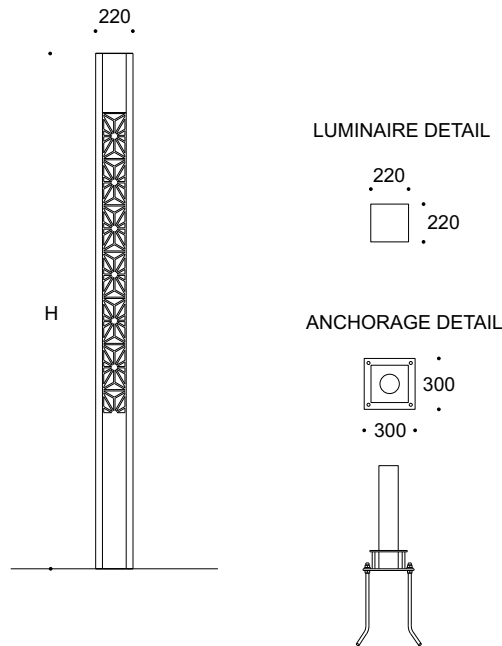

Information

CODE	POWER CONSUMPTION	LUMEN OUTPUT (lm) 3000K / 4000K	COLOUR TEMPERATURE	H (mm)
LB1362	54W	7290 / 7668	3000K / 4000K	4000 - 6000

*Anchorage set included.

*Flange cover to be ordered separately.

Light Distribution Curve

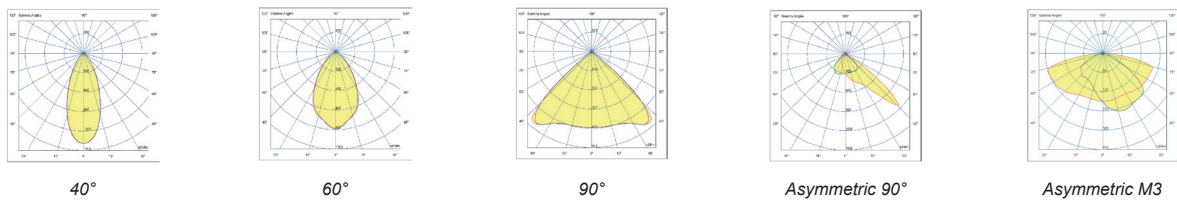

Accessories



DECO 101



DECO 102



DECO 103



DECO 104

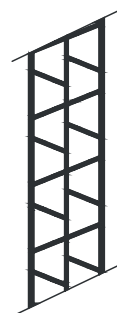

DECO 105



DECO 106



DECO 107

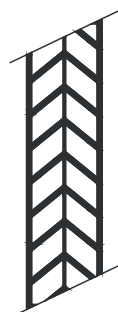

DECO 108

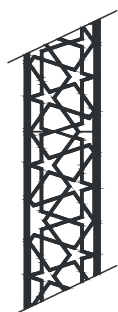

DECO 109

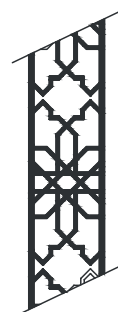

DECO 110



DECO 111



DECO 112



DECO 113



DECO 114



DECO 115