



Key Features

iAxis Mono is a durable and virtually maintenance free surface mounted luminaire suitable for a wide range of wall washing, accent, surface grazing and indirect lighting applications in architectural, hospitality and retail environments. It has multiple customization options to illuminate interior walls, exterior facades and unique architectural details. Confirms vibration standards for bridge applications. Plug & Play system ensures easy installation, fast adjustment and intuitive programming with self-addressing.

Designed to last in extremely harsh environments. Suitable for wet locations with high protection rating and marine grade finish option.

Monochrome or DALI controllable, easy to install with the integrated universal power supply and connect via combined power and data connectors.



Key Data

LED Type	High efficiency LEDs, available in 2700K, 3000K, 4000K, 5000K, 6500K CCT tolerance within a 3-step MacAdams ellipse and LM80 compliant. Custom LED color combinations available.
Nominal Voltage	220V-240V AC, 50/60Hz
Color Rendering Index	CRI ≥ 80 standard and CRI ≥ 90 on request.
Optics	Standard: 8° / 12° / 25° / 30° / 45° / 60° / 90° / 18°x38° / 10°x60° / 25°x50° Asymmetrical Linear Wallwash. Custom optics upon request.
Materials	Corrosion resistant extruded anodized aluminium housing (EN AW-6060) with stainless steel screws (A4 grade) and silicone rubber gaskets. End- to-end connection via power connectors. Includes adjustable mounting brackets. Power unit is built in.
Optional Coating	Marine grade.
Diffuser	High impact and heat resistant polycarbonate with UV protection.
LED Life Time	L90 - B10 > 100,000h
Operating Temperature	-40°C / +55°C
Power Factor	>0.95
Control Systems	DALI Interface.
Protection Class	IP67
Impact Resistance	IK10
Insulation Class	Class I
Conformity	Complies with European Standards EN 60598 and CE certified.

Technical Drawing

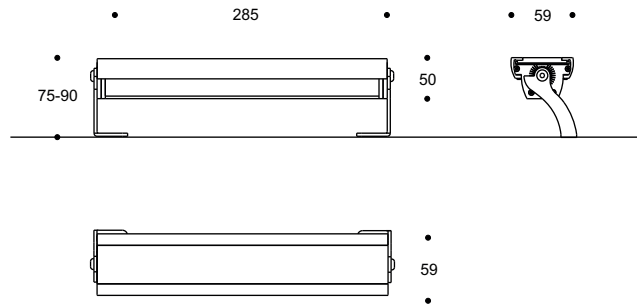

Information

CODE	LENGTH (mm)	PITCH (mm)	LED QTY	POWER CONSUMPTION 350mA	POWER CONSUMPTION 500mA	LUMEN OUTPUT (lm) 3000K / 4000K 350mA	LUMEN OUTPUT (lm) 3000K / 4000K 500mA
AR9154411	285	41	6	6W	9W	810 / 852	1215 / 1278

Light Distribution Curve

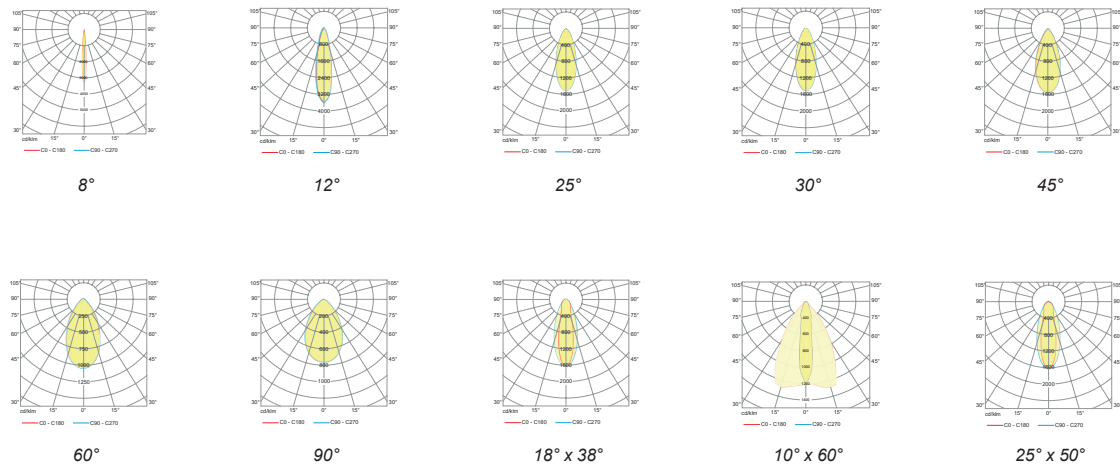

Accessories



Glare Shield
One Sided Code: GS2201
Two Sided Code: GS2202



IP68 Plug Power Connector Set
Code: CON1201