

PRODUCT FEATURES:

iCubus offers a wide range of options for realizing impressive and efficient lighting concepts and individual design solutions within urban spaces. Functional LED outdoor pole mounted luminaire, with wide range of beams, sizes and powers, ideal for residential, urban and landscape lighting. Architectural floodlight range inspires architects, designers and system integrators with its exceptional quality, a variety of beam angles and remarkable creativity. Designed to last in extremely harsh environments.

RECOMMENDATIONS FOR THE USER:

- 1) Before the installation, make sure that there is no voltage.
- 2) Do not touch the fitting when it is working on / switched on
- 3) Do not look at the fitting directly or from a short distance.
- 4) Disconnect / switch off the fitting before changing the lamps
- 5) The safety of this fixture is guaranteed only if you comply with these instructions.

NOTES:

- Technical amendments are reserved.
- CE – Conformity mark
- The manufacturer is then discharged from liability when damage is caused by improper use or installation.
- Clean luminaire regularly with solvent-free cleansers from dirt and deposits. Do not use high pressure cleaners.
- Cleaning agents containing hydrochloric acid and chlorides should never be used.

- 1) The M5 setscrews on the projector mounting outer table are loosened and the mounting inner table is removed.

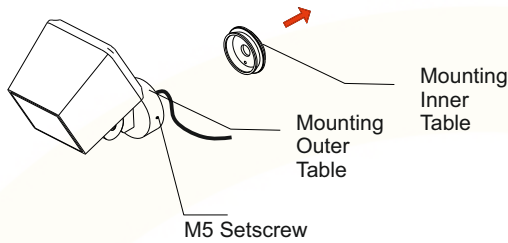

- 2) - The mounting inner table is tightened to the mounting points on the pole by bolts.
- The projector's cable is threaded into the pole.
- The projector is placed and the M5 setscrews are tightened back.

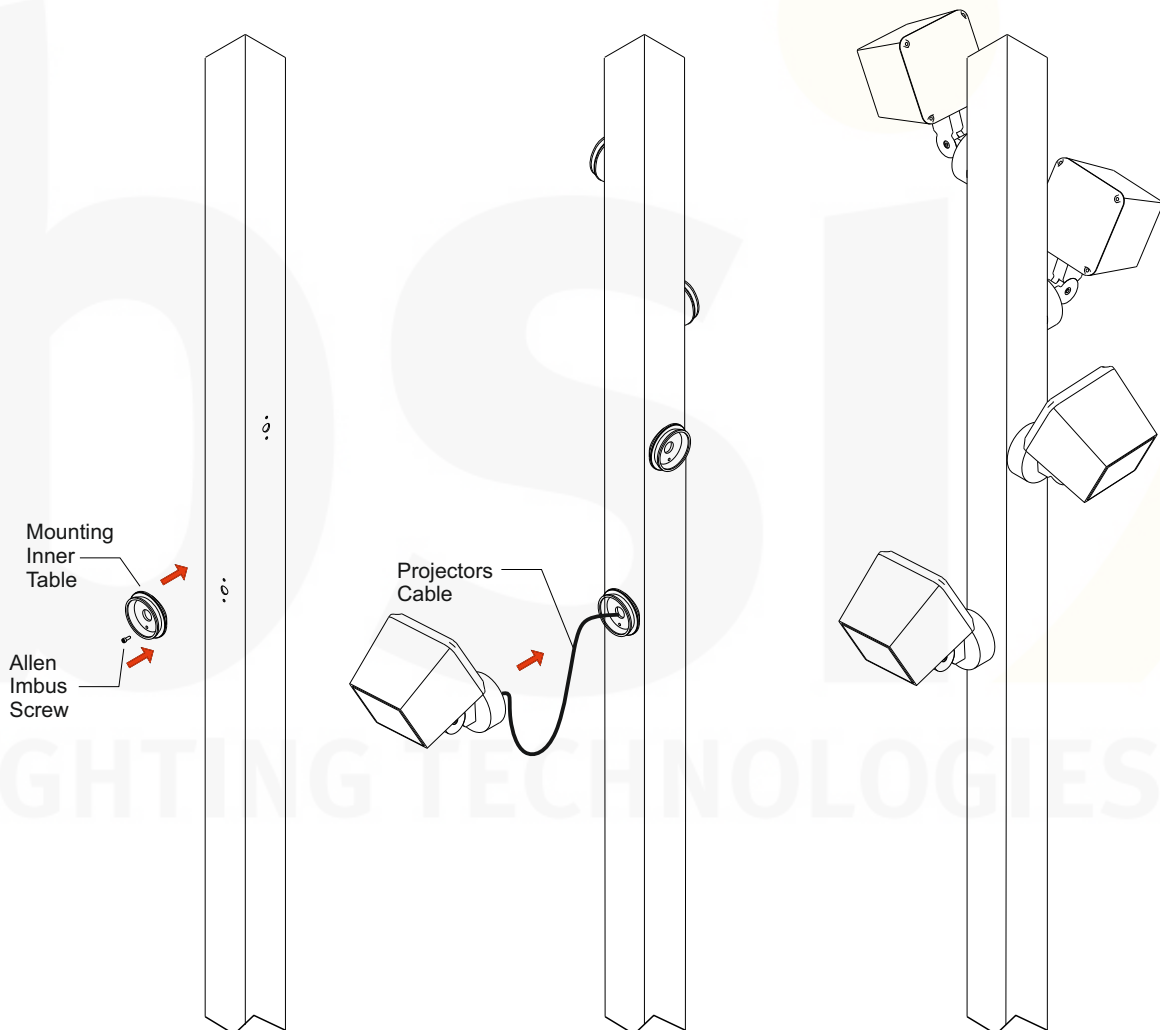

- 3) Gijons tightened 2.5cm to the anchor.
**Do not remove the screws on the anchorage*

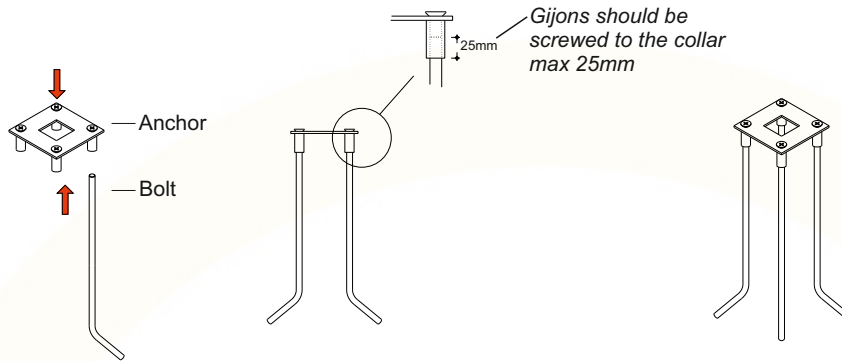

- 4) - The prepared anchor is embedded in the concrete and leveled.
 - After the concrete is dried, the energy cabling is done.

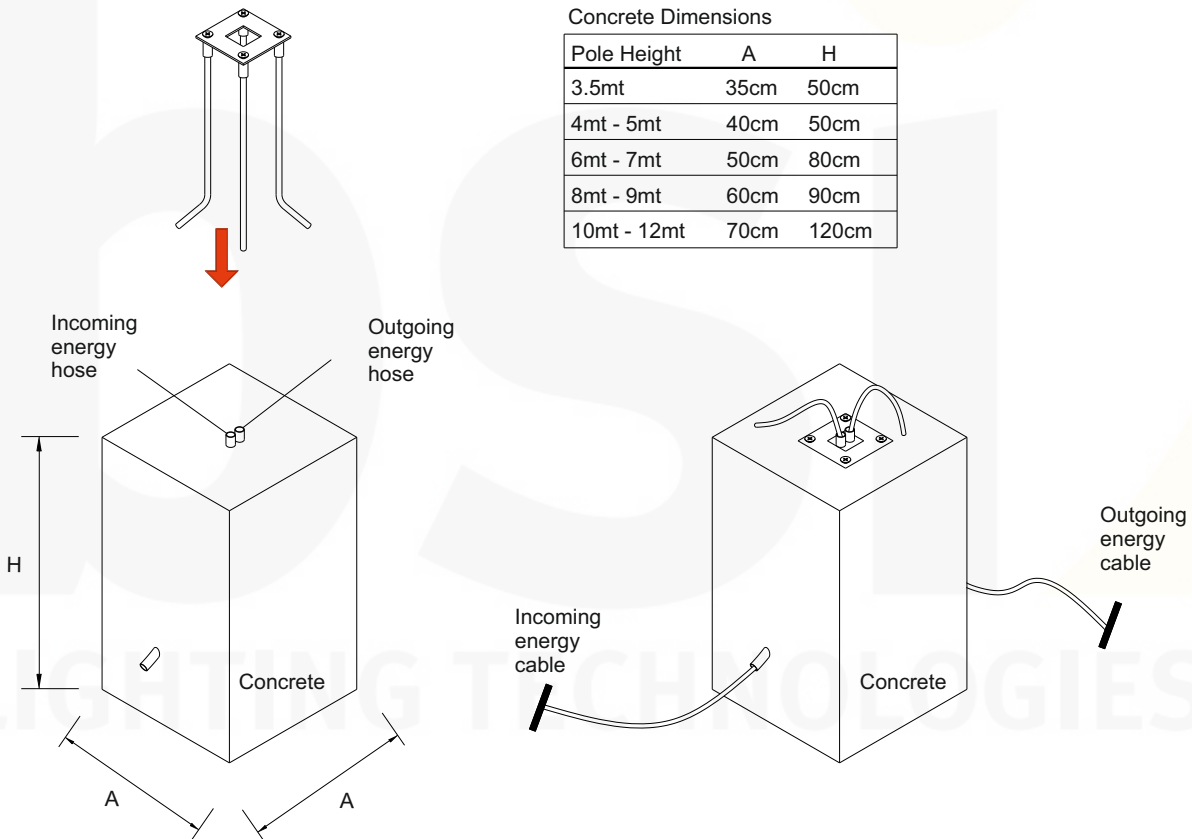

- 5) - The fuse cover is removed from the pole.
- Temporary screws on the anchor are removed.
 - The pole is placed on the anchor and screwed into the anchor with new inox screws.
 - Fuse box is removed.
 - Electrical connection is done.

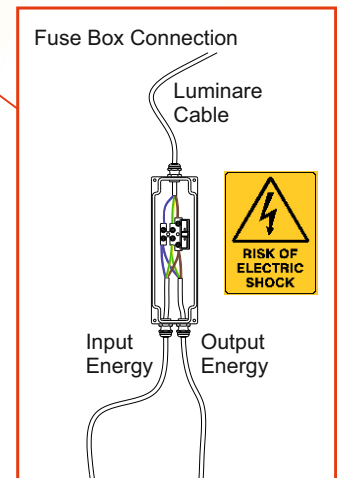
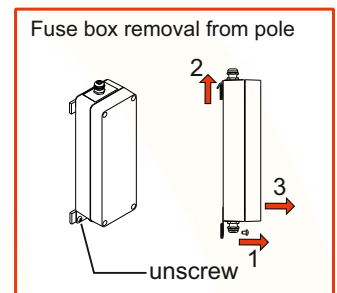
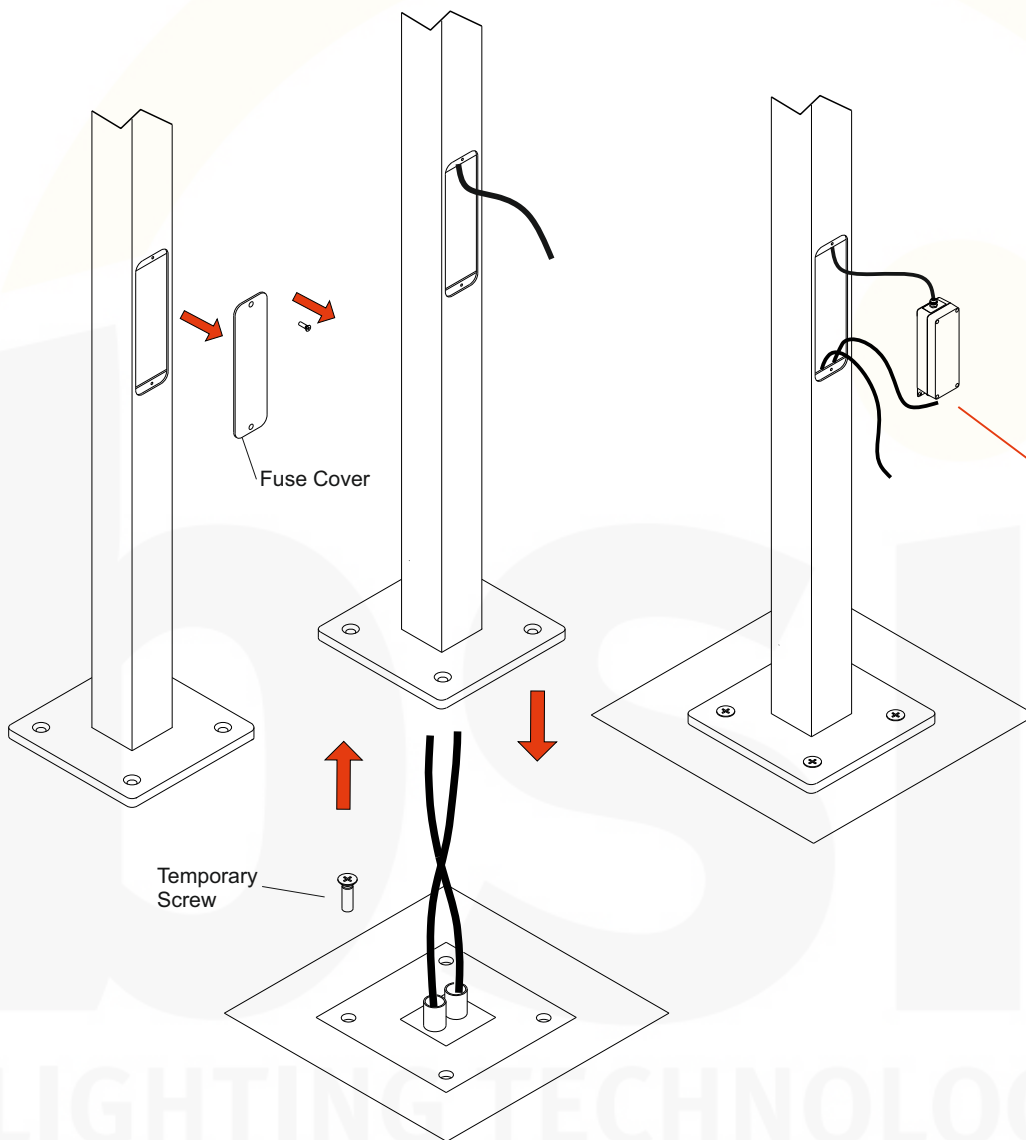

(L) Brown
(+) Yellow - Green
(N) Blue

**Please contact us for cables if in different colors.*

DALI CONTROL CONNECTION

(L) Brown
(+) Green - Yellow
(N) Blue
(DaL) Black
(DaN) Gray

**Please contact us for cables if in different colors.*

6) - The fusebox and the fuse cover is re-mounted.

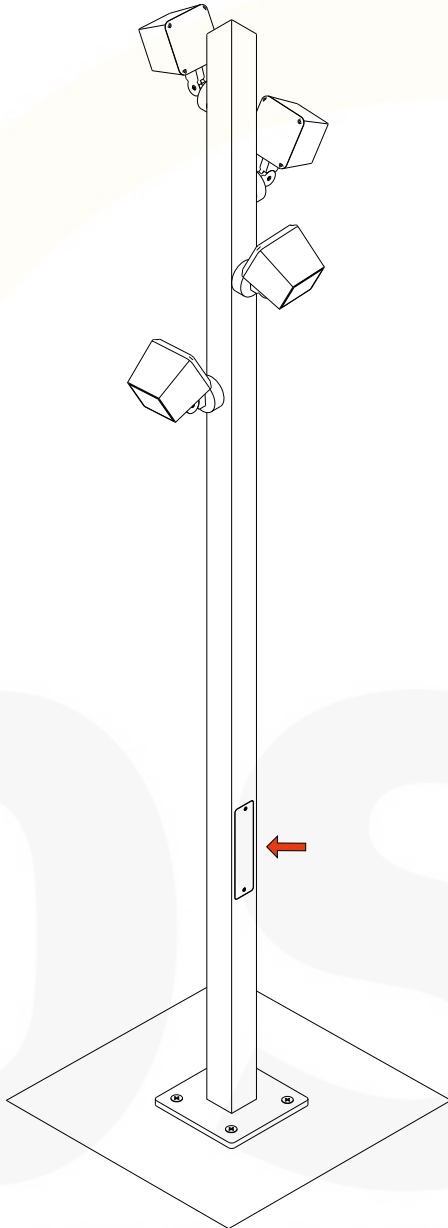

Warning:

- Do not cut-off or damage the cables of the products supplied as sockets. Otherwise, water may enter to the luminaire through cable and damage the electronic parts inside.
- If you make the electrical connecton, except for IP.68 Terminal Block - IP.68 Plug connector - IP.68 socket; the connectons must be under IP protecton. Otherwise, water may enter to the luminaire through cable and damage the electronic parts inside.
- The IP68 Connecting kits must be assembled in accordance with the installaton instructions. Otherwise, water may enter to the luminaire through cable and damage the electronic parts inside.

Out of Warranty Stuations:

Product last output cable is not protected IP67-IP68.

Faulty electrical connecton.

Wrong IP68 socket-terminal block- plug connector connecton.
(Wrong opening of the cable length, fauly tightening the screws etc.)

If the IP68 Connecting kits are under water.

LIGHTING TECHNOLOGIES