

Urban & Area

iErgo Series provide an elegant solution for lighting various environments in towns and cities such as urban and residential streets, squares, parks, pedestrian areas and car parks. Functional LED outdoor pole mounted luminaire, with wide range of beams, sizes and powers, ideal for residential, urban and landscape lighting.

iErgo offers a wide range of options for realizing impressive and efficient lighting concepts and individual design solutions within urban spaces. Architectural floodlight range inspires architects, designers and system integrators with its exceptional quality, a variety of beam angles and remarkable creativity.

High Performance and Creative Freedom

With precise optics, the iErgo series are ideal for squares, roads, pedestrian precincts, car parks and sports grounds.

The combination of floodlights with different optics makes creative lighting scenarios possible.

Integrated Solution and Modern Design

Plug and play built-in system with the fully integrated universal power supply unit.

The entire family appears in a uniform and durable modern design. A wide range of attractive accessories; honeycomb louvre, glare shield, as well as wide selection of mounting arms.

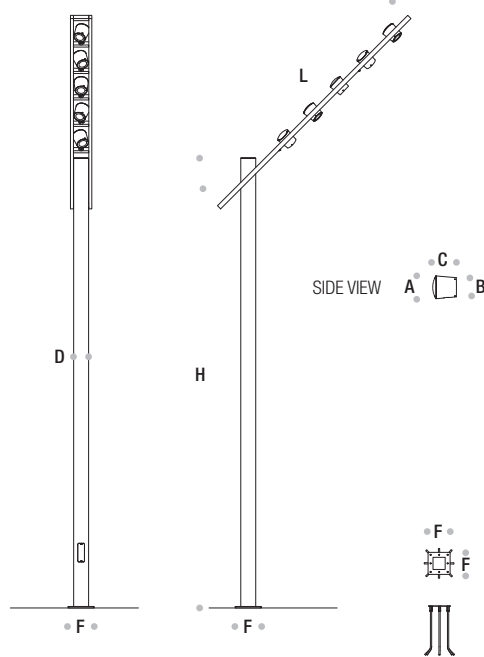
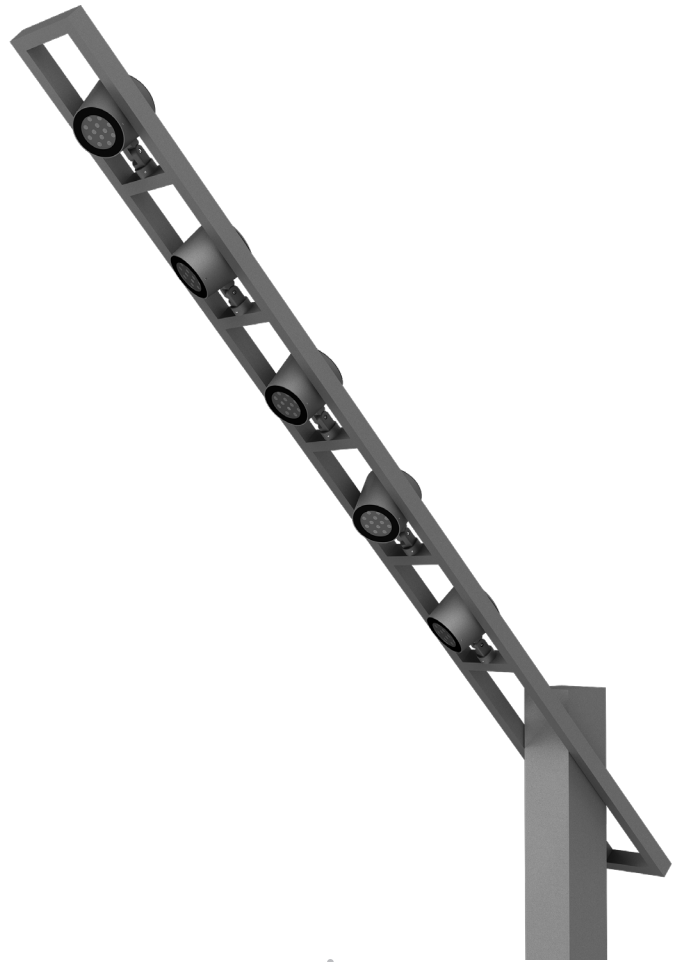

iErgo Supra

Codes	Power	Colour Temperature	A (mm)	B (mm)	C (mm)	L (mm)	D (mm)	H (mm)	F (mm)
UA19111	48W	3000K / 4000K	190	160	197	3600	200x200	6000 / 8000	350
UA19112	72W	3000K / 4000K	238	200	240	3600	200x200	6000 / 8000	350
UA19113	108W	3000K / 4000K	238	200	240	3600	200x200	6000 / 8000	350
UA19114	144W	3000K / 4000K	238	200	240	3600	200x200	6000 / 8000	350

iErgo Supra
iErgo Supra



For detailed information about the iErgo Supra

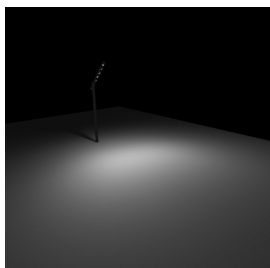

30 degree

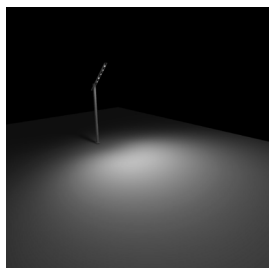

45 degree

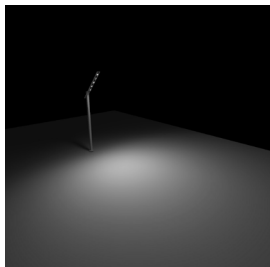

60 degree

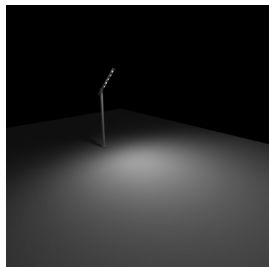

90 degree

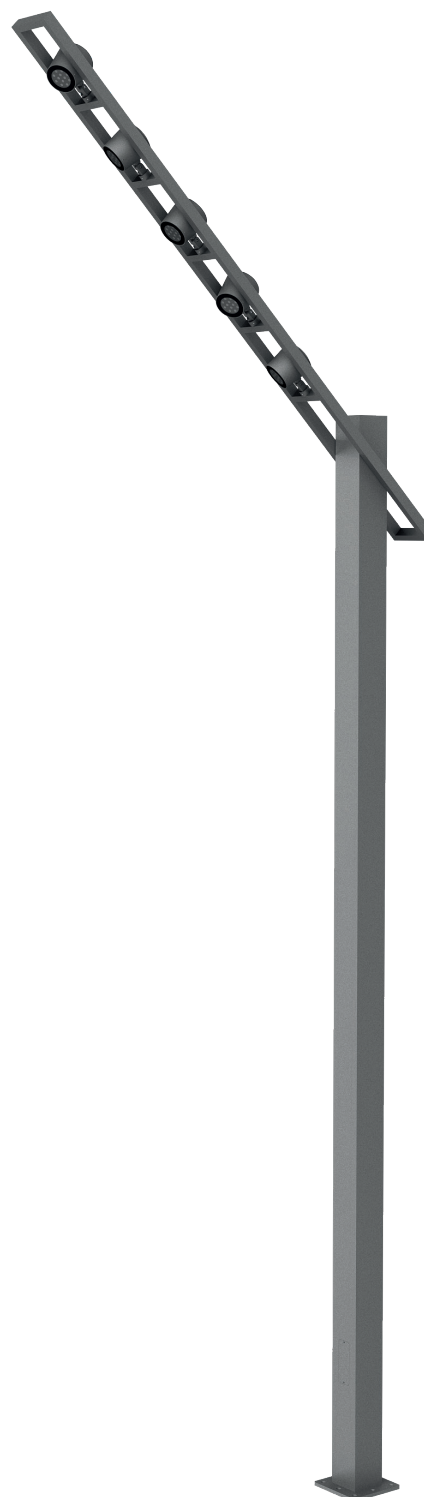

Technical Features

Corrosion resistant double layer polyester powder coated paint finish die cast aluminium housing with stainless steel screws (A4 grade) and silicone gaskets. Power unit is built in. Tilttable by up to 45° horizontal and vertical axis. Available in anthracite gray as a standard finish or any desired RAL colour. Adjustable mounting bracket made of aluminium with polyester powder coating. Aluminium pole 200x200mm. Optional pole heights and floodlight arrangements.

LED MacAdam Step 3

Nominal Voltage 220V-240V AC, 50/60Hz

Operating Temperature -40°C / +55°C

Control Systems 1-10V DIM, DALI Interface

Protection Class IP66

Impact Resistance IK09

Insulation Class I

Complies with EN60598 and relevant standards.