

Technical Drawing

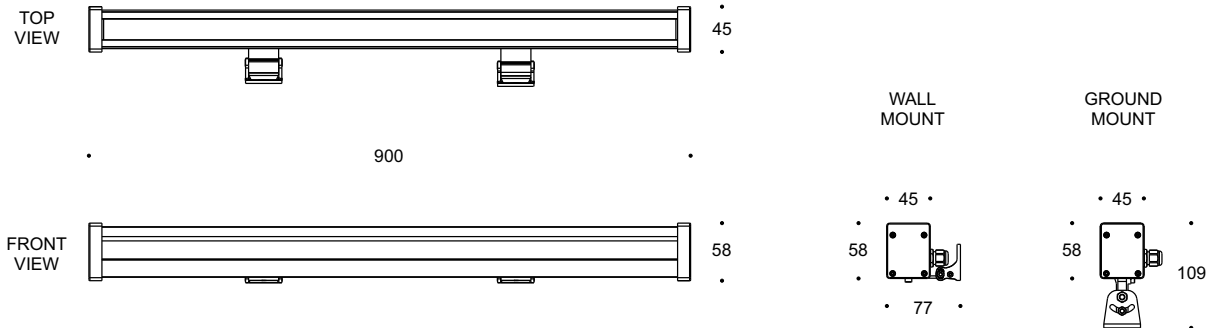

Information

CODE	LENGTH (mm)	LED QTY	POWER CONSUMPTION	LUMEN OUTPUT (lm) 2700K / 6500K
AR9344702 TUNABLE	900	96	31W	4101

Light Distribution Curve

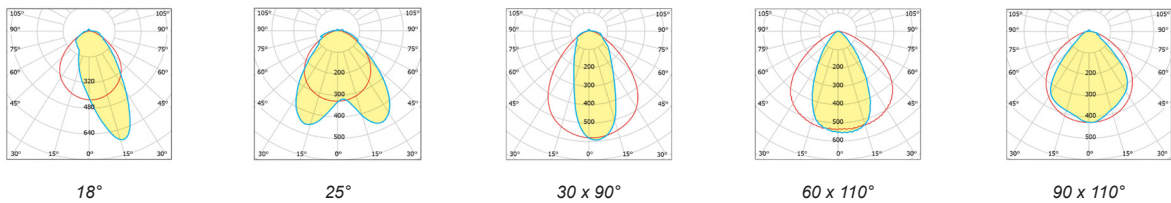

Accessories



Wall Mounting Bracket
Code: WB1001



Ground Mounting Bracket
Code: GB1001



IP68 Plug Power Connector Set (Two pieces)
Code: CON1202



T-Connector
Code: TC4001